

OTO CAN REF	OC 105
	
AÇIKLAMA	HYUNDAI H100 STAREX KMY PANELVAN ÜST SALINCAK BURCU TAKIM
DESCRIPTION	BUSH WITH PLASTIC SET
ORJINAL NO	
OEM REF	

OTO CAN REF	OC 106
	
AÇIKLAMA	HYUNDAI H100 STAREX KMY PANELVAN ÜST SALINCAK BURCU UZUN
DESCRIPTION	BUSH WITH PLASTIC LONG
ORJINAL NO	
OEM REF	

OTO CAN REF	OC 107
	
AÇIKLAMA	HYUNDAI H100 STAREX KMY PANELVAN ÜST SALINCAK BURCU KISA
DESCRIPTION	BUSH WITH PLASTIC SHORT
ORJINAL NO	
OEM REF	

OTO CAN REF	OC 403
	
AÇIKLAMA	L300 MITSUBUCHI PANELVAN ÜST SALINCAK BURCU TAKIM
DESCRIPTION	BUSH SET
ORJINAL NO	
OEM REF	

OTO CAN REF	OC 404
	
AÇIKLAMA	L300 MITSUBUCHI PANELVAN ÜST SALINCAK BURCU UZUN
DESCRIPTION	BUSH LONG
ORJINAL NO	
OEM REF	

OTO CAN REF	OC 405
	
AÇIKLAMA	L300 MITSUBUCHI PANELVAN ÜST SALINCAK BURCU KISA
DESCRIPTION	BUSH SHORT
ORJINAL NO	
OEM REF	

Bu kataloğtaki araç, marka, model ve OEM numaraları bilgilendirme amaçlı kullanılmıştır.

OTO CAN REF	OC 114
	
AÇIKLAMA	HYUNDAI H100 STAREX KMY PANELVAN ALT SALINCAK BURCU
DESCRIPTION	BUSH R/L
ORJINAL NO	54402-4B000
OEM REF	

OTO CAN REF	OC 115
	
AÇIKLAMA	HYUNDAI H100 STAREX KMY PANELVAN ALT SALINCAK ÜST TAKOZ
DESCRIPTION	LOWER SILENT UPPER SUPPORT R/L
ORJINAL NO	5756043150
OEM REF	

OTO CAN REF	OC 214
	
AÇIKLAMA	HYUNDAI KAMYONET ALT SALINCAK BURCU
DESCRIPTION	BUSH R/L
ORJINAL NO	545224B000
OEM REF	

OTO CAN REF	OC 314
	
AÇIKLAMA	HYUNDAI PANELVAN ALT SALINCAK BURCU R/L
DESCRIPTION	BUSH R/L
ORJINAL NO	5452243002
OEM REF	

OTO CAN REF	OC 412
	
AÇIKLAMA	L300 MITSUBICHI PANELVAN-MİNİBÜS ALT SALINCAK BURCU R/L
DESCRIPTION	BUSH R/L
ORJINAL NO	MR-319536
OEM REF	

OTO CAN REF	OC 505
	
AÇIKLAMA	HYUNDAI ACCENT SALINCAK BURCU ESKİ MODEL R 94-00
DESCRIPTION	BUSH OLD MODEL
ORJINAL NO	5455622100
OEM REF	

Bu kataloktaki araç, marka, model ve OEM numaraları bilgilendirme amaçlı kullanılmıştır.

OTO CAN REF	OC 506
	
AÇIKLAMA	HYUNDAI ACCENT SALINCAK BURCU ESKİ MODEL L 94-00
DESCRIPTION	BUSH OLD MODEL
ORJINAL NO	5451222100
OEM REF	

OTO CAN REF	OC 507
	
AÇIKLAMA	HYUNDAI ACCENT SALINCAK BURCU ESKİ MODEL KÜÇÜK 94-00
DESCRIPTION	BUSH SMALL OLD MODEL
ORJINAL NO	5455122100
OEM REF	

OTO CAN REF	OC 514
	
AÇIKLAMA	HYUNDAI ACCENT SALINCAK BURCU YENİ MODEL R/L 00-06
DESCRIPTION	BUSH NEW MODEL
ORJINAL NO	
OEM REF	

OTO CAN REF	OC 515
	
AÇIKLAMA	HYUNDAI ACCENT/GETZ/ERA/KIA RIO SALINCAK BURCU R/L
DESCRIPTION	BUSH SMALL NEW MODEL
ORJINAL NO	
OEM REF	

OTO CAN REF	OC 605
	
AÇIKLAMA	HYUNDAI GETZ SALINCAK BURCU BÜYÜK R/L 02-...
DESCRIPTION	BUSH BIG R/L
ORJINAL NO	5455622100
OEM REF	

OTO CAN REF	OC 1805
	
AÇIKLAMA	HYUNDAI ERA SALINCAK BURCU BÜYÜK R/L 06-...
DESCRIPTION	BUSH BIG R/L
ORJINAL NO	
OEM REF	

Bu kataloğtaki araç, marka, model ve OEM numaraları bilgilendirme amaçlı kullanılmıştır.

OTO CAN REF	OC 713
	
AÇIKLAMA	PEUGEOT-CITROEN SALINCAK BURCU KÜÇÜK R/L
DESCRIPTION	BUSH SMALL R/L
ORJINAL NO	96110483
OEM REF	

OTO CAN REF	OC 715
	
AÇIKLAMA	PEUGEOT-CITROEN SALINCAK BURCU BÜYÜK R/L
DESCRIPTION	BUSH BIG R/L
ORJINAL NO	352359
OEM REF	

OTO CAN REF	OC 905
	
AÇIKLAMA	FIAT UNO SALINCAK BURCU KÜÇÜK
DESCRIPTION	BUSH SMALL R/L
ORJINAL NO	5927292
OEM REF	

OTO CAN REF	OC 906
	
AÇIKLAMA	FIAT UNO SALINCAK BURCU BÜYÜK
DESCRIPTION	BUSH BIG R/L
ORJINAL NO	5927293
OEM REF	

OTO CAN REF	OC 907
	
AÇIKLAMA	FIAT TEMPRA SALINCAK BURCU KÜÇÜK Ø 20.90-19.90 mm
DESCRIPTION	BUSH SMALL R/L
ORJINAL NO	5455622100
OEM REF	

OTO CAN REF	OC 908
	
AÇIKLAMA	FIAT TEMPRA SALINCAK BURCU BÜYÜK Ø 20.90-19.90 mm
DESCRIPTION	BUSH BIG R
ORJINAL NO	7601065
OEM REF	

Bu kataloktaki araç, marka, model ve OEM numaraları bilgilendirme amaçlı kullanılmıştır.

OTO CAN REF	OC 909
	
AÇIKLAMA	FIAT TEMPRA SALINCAK BURCU BÜYÜK Ø 20.90-19.90 mm
DESCRIPTION	BUSH BIG L
ORJINAL NO	7601068
OEM REF	

OTO CAN REF	OC 922
	
AÇIKLAMA	FIAT ALBEA SALINCAK BURCU R 03-...
DESCRIPTION	BUSH BIG R
ORJINAL NO	46551378
OEM REF	

OTO CAN REF	OC 923
	
AÇIKLAMA	FIAT ALBEA SALINCAK BURCU L 03-...
DESCRIPTION	BUSH BIG L
ORJINAL NO	46551377
OEM REF	

OTO CAN REF	OC 929
	
AÇIKLAMA	FIAT DOBLO SALINCAK BURCU R 00-...
DESCRIPTION	BUSH BIG R
ORJINAL NO	46551378
OEM REF	

OTO CAN REF	OC 930
	
AÇIKLAMA	FIAT DOBLO SALINCAK BURCU L 00-...
DESCRIPTION	BUSH BIG L
ORJINAL NO	46551377
OEM REF	

OTO CAN REF	OC 924
	
AÇIKLAMA	FIAT DOBLO-PALIO-SIENA SALINCAK BURCU KÜÇÜK 00-...
DESCRIPTION	BUSH SMALL R/L
ORJINAL NO	46421522
OEM REF	

Bu kataloktaki araç, marka, model ve OEM numaraları bilgilendirme amaçlı kullanılmıştır.

OTO CAN REF	OC 936
	
AÇIKLAMA	FIAT DOBLO AMORTİSÖR BURCU
DESCRIPTION	SUSPANSION BUSH
ORJINAL NO	88B0023040
OEM REF	

OTO CAN REF	OC 1003
	
AÇIKLAMA	SUZUKI-DAEWOO SALINCAK BURCU R/L
DESCRIPTION	BUSH R/L
ORJINAL NO	
OEM REF	

OTO CAN REF	OC 1105
	
AÇIKLAMA	NISSAN PRIMERA SALINCAK BURCU BÜYÜK
DESCRIPTION	BUSH BIG
ORJINAL NO	5454190J02
OEM REF	

OTO CAN REF	OC 1106
	
AÇIKLAMA	NISSAN PRIMERA SALINCAK BURCU SMALL
DESCRIPTION	BUSH SMALL
ORJINAL NO	5454590J00
OEM REF	

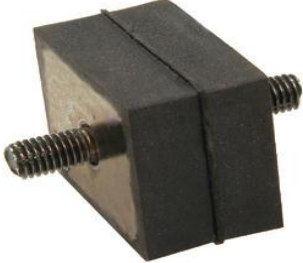
OTO CAN REF	OC 1405
	
AÇIKLAMA	RENAULT 12 VİTES TERAZİ TAKOZU
DESCRIPTION	BALANCE SUPPORT FOR RENAULT 12
ORJINAL NO	7700575465
OEM REF	

OTO CAN REF	OC 1406
	
AÇIKLAMA	RENAULT 12 ALT SALINCAK BURCU
DESCRIPTION	BUSH
ORJINAL NO	77000001600
OEM REF	

Bu kataloktaki araç, marka, model ve OEM numaraları bilgilendirme amaçlı kullanılmıştır.

OTO CAN REF	OC 1407
	
AÇIKLAMA	RENAULT 12 ÜST SALINCAK BURCU
DESCRIPTION	BUSH
ORJINAL NO	7700040000
OEM REF	

OTO CAN REF	OC 1408
	
AÇIKLAMA	RENAULT 12 ROTBAŞI BURCU
DESCRIPTION	BUSH
ORJINAL NO	7700504987
OEM REF	

OTO CAN REF	OC 1409
	
AÇIKLAMA	RENAULT 9-11-21 ALT SALINCAK BURCU
DESCRIPTION	BUSH
ORJINAL NO	7700000681
OEM REF	

OTO CAN REF	OC 1410
	
AÇIKLAMA	RENAULT 19-MEGANE 1 ALT SALINCAK BURCU
DESCRIPTION	BUSH
ORJINAL NO	7700840741
OEM REF	

OTO CAN REF	OC 1411
	
AÇIKLAMA	RENAULT 21-CONCORD ALT SALINCAK BURCU
DESCRIPTION	BUSH
ORJINAL NO	7700754515
OEM REF	

OTO CAN REF	OC 1413
	
AÇIKLAMA	LAGUNA II/TRAFIC SALINCAK BURCU KÜÇÜK
DESCRIPTION	BUSH SMALL
ORJINAL NO	8200002869
OEM REF	

Bu kataloaktaki araç, marka, model ve OEM numaraları bilgilendirme amaçlı kullanılmıştır.

OTO CAN REF	OC 1413
	
AÇIKLAMA	LAGUNA II/TRAFIC SALINCAK BURCU BÜYÜK
DESCRIPTION	BUSH BIG
ORJINAL NO	8200002869
OEM REF	

OTO CAN REF	OC 1414/1419/1420
	
AÇIKLAMA	MEGANE II/MODUS/CLIO III/KANGOO III ALT SALINCAK BURCU BÜYÜK
DESCRIPTION	BUSH BIG
ORJINAL NO	8200586567/8200586567/ 8200586561
OEM REF	

OTO CAN REF	OC 1421/1432
	
AÇIKLAMA	MEGANE II/KANGOO III SALINCAK BURCU KÜÇÜK
DESCRIPTION	BUSH SMALL
ORJINAL NO	8200242025/8200586561
OEM REF	

OTO CAN REF	OC 1422
	
AÇIKLAMA	MEGANE III-FLUENCE SALINCAK BURCU KÜÇÜK
DESCRIPTION	BUSH SMALL
ORJINAL NO	545014055R/54500927R
OEM REF	

OTO CAN REF	OC 1423
	
AÇIKLAMA	MEGANE III-FLUENCE SALINCAK BURCU BÜYÜK
DESCRIPTION	BUSH BIG
ORJINAL NO	545014055R/545009207R
OEM REF	

OTO CAN REF	OC 1430
	
AÇIKLAMA	CLIO II/KANGOO SALINCAK BURCU R/L
DESCRIPTION	BUSH R/L
ORJINAL NO	545014055R/545009207R
OEM REF	

Bu kataloktaki araç, marka, model ve OEM numaraları bilgilendirme amaçlı kullanılmıştır.

OTO CAN REF	OC 1417
	
AÇIKLAMA	DACIA LOGAN SALINCAK BURCU
DESCRIPTION	BUSH
ORJINAL NO	6001547140
OEM REF	

OTO CAN REF	OC 1418
	
AÇIKLAMA	DACIA SANDERO SALINCAK BURCU
DESCRIPTION	BUSH
ORJINAL NO	8200820918
OEM REF	

OTO CAN REF	OC 1439
	
AÇIKLAMA	DACIA DUSTER SALINCAK BURCU
DESCRIPTION	BUSH
ORJINAL NO	
OEM REF	

OTO CAN REF	OC 1431
	
AÇIKLAMA	MEGANE II MOTOR BEŞİK BURCU
DESCRIPTION	BUSH
ORJINAL NO	8200742906
OEM REF	

OTO CAN REF	OC 1437
	
AÇIKLAMA	RENAULT KANGO AMORTİSÖR ÜST BURCU
DESCRIPTION	BUSH SUSPANSION
ORJINAL NO	
OEM REF	

OTO CAN REF	OC 1438
	
AÇIKLAMA	RENAULT KANGO AMORTİSÖR ALT BURCU
DESCRIPTION	BUSH SUSPANSION
ORJINAL NO	545014055R/545009207R
OEM REF	

Bu kataloktaki araç, marka, model ve OEM numaraları bilgilendirme amaçlı kullanılmıştır.

OTO CAN REF	OC 1444
	
AÇIKLAMA	MEGANE II AMORTİSÖR BURCU ARKA ALT
DESCRIPTION	BUSH SUSPANSION
ORJINAL NO	8200038257-58
OEM REF	

OTO CAN REF	OC 1445
	
AÇIKLAMA	RENAULT MASTER III / OPEL MOVANO DİFRANSİYEL MİLİ TAKOZU
DESCRIPTION	DIFFERENTIEL SUPPORT
ORJINAL NO	370007837R
OEM REF	

OTO CAN REF	OC 1448
	
AÇIKLAMA	DACIA DUSTER-LOGGY-LAGAN II-DOCKER RADYATÖR ALT LASTİĞİ
DESCRIPTION	RADIATOR LOWER RUBER
ORJINAL NO	215081131R
OEM REF	

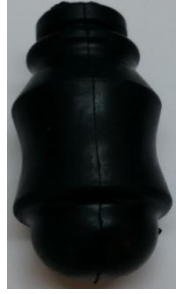
OTO CAN REF	OC938
	
AÇIKLAMA	FIAT PALIO-SIENA VİRAJ UÇ LASTİĞİ
DESCRIPTION	STABILIZER RUBER
ORJINAL NO	
OEM REF	

OTO CAN REF	OC939
	
AÇIKLAMA	FIAT FIORINO/BIPPER/BENO AMORTİSÖR ÜST BURCU
DESCRIPTION	SHOCK UPPER BUSH
ORJINAL NO	
OEM REF	

OTO CAN REF	OC940
	
AÇIKLAMA	FIAT FIORINO/BIPPER/BENO AMORTİSÖR ALT BURCU
DESCRIPTION	SHOCK LOWER BUSH
ORJINAL NO	
OEM REF	

Bu kataloktaki araç, marka, model ve OEM numaraları bilgilendirme amaçlı kullanılmıştır.

OTO CAN REF	OC937
	
AÇIKLAMA	FIAT DOBLO AMORTİSÖR ALT BURCU
DESCRIPTION	SHOCK LOWER BUSH
ORJINAL NO	
OEM REF	

OTO CAN REF	OC1111
	
AÇIKLAMA	NISSAN QASHQAI BEŞİK BURCU UZUN
DESCRIPTION	
ORJINAL NO	54466-JD000
OEM REF	

OTO CAN REF	OC1112
	
AÇIKLAMA	NISSAN QASHQAI BEŞİK BURCU KISA
DESCRIPTION	
ORJINAL NO	54467-BR00A
OEM REF	

OTO CAN REF	OC1113
	
AÇIKLAMA	NISSAN QASHQAI 2007-2013-RENAULT KOLEOS 2008-2009 SAL. BURCU BÜYÜK
DESCRIPTION	BUSH BIG
ORJINAL NO	
OEM REF	

OTO CAN REF	OC1114
	
AÇIKLAMA	NISSAN QASHQAI 2007-2013-RENAULT KOLEOS 2008-2009 SAL. BURCU KÜÇÜK
DESCRIPTION	BUSH SMALL
ORJINAL NO	54570-BB00A
OEM REF	

OTO CAN REF	OC1115
	
AÇIKLAMA	NISSAN QASHQAI ARKA DINGİL BURCU
DESCRIPTION	REAR AXLE BUSH
ORJINAL NO	55045 JD00B
OEM REF	

Bu kataloktaki araç, marka, model ve OEM numaraları bilgilendirme amaçlı kullanılmıştır.

OTO CAN REF	OC1910
	
AÇIKLAMA	HYUNDAI I 30 SALINCAK BURCU BÜYÜK
DESCRIPTION	BUSH BIG
ORJINAL NO	
OEM REF	

OTO CAN REF	OC4001
	
AÇIKLAMA	FORD C MAX/ FOCUS SALINCAK BURCU R/L
DESCRIPTION	
ORJINAL NO	1234275
OEM REF	

OTO CAN REF	OC1450
	
AÇIKLAMA	MEGANE III/FLUENCE/SCENIC III BEŞİK BURCU BÜYÜK
DESCRIPTION	BUSH BIG
ORJINAL NO	554640005R
OEM REF	

OTO CAN REF	OC1451
	
AÇIKLAMA	MEGANE III/FLUENCE/SCENIC III BEŞİK BURCU KÜÇÜK
DESCRIPTION	BUSH SMALL
ORJINAL NO	54466000
OEM REF	

OTO CAN REF	OC5001
	
AÇIKLAMA	MAZDA III(02-09)/MAZDA V SALINCAK BURCU R/L
DESCRIPTION	
ORJINAL NO	30678440
OEM REF	

OTO CAN REF	OC1452
	
AÇIKLAMA	MEGANE I/CLIO KANGO/ R19 RADYATÖR ALT LASTİĞİ
DESCRIPTION	RADIATOR LOWER RUBER
ORJINAL NO	7700842041
OEM REF	

Bu kataloktaki araç, marka, model ve OEM numaraları bilgilendirme amaçlı kullanılmıştır.

OTO CAN REF	OC1453
	
AÇIKLAMA	RENAULT LATITUDE/DACIA MCV/SANDERO/DOKKER/LODGY LASTİK TAPA
DESCRIPTION	RADIATOR RUBBER
ORJINAL NO	215060007R
OEM REF	

OTO CAN REF	OC 1454
	
AÇIKLAMA	RENAULT KANGOO RADYATÖR LASTİK TAPA
DESCRIPTION	RADIATOR LOWER RUBER
ORJINAL NO	
OEM REF	

OTO CAN REF	OC 1455
	
AÇIKLAMA	MEGANE II RADYATÖR LASTİĞİ BÜYÜK
DESCRIPTION	RADIATOR RUBBER
ORJINAL NO	
OEM REF	

OTO CAN REF	OC 1456
	
AÇIKLAMA	DACIA LOGAN/SANDERO/LOGY AMORTİSÖR ÜST BURCU
DESCRIPTION	SHOCK UPPER BUSH
ORJINAL NO	
OEM REF	

OTO CAN REF	OC 1457
	
AÇIKLAMA	NISSAN NAVARA 2005-.... ALT SALINCAK TAKOZU
DESCRIPTION	LOWER SILENT UPPER SUPPORT R/L
ORJINAL NO	
OEM REF	

OTO CAN REF	OC 1458
	
AÇIKLAMA	RENAULT CLIO IV RADYATÖR ALT LASTİĞİ
DESCRIPTION	RADIATOR LOWER RUBER
ORJINAL NO	
OEM REF	

Bu kataloktaki araç, marka, model ve OEM numaraları bilgilendirme amaçlı kullanılmıştır.

OTO CAN REF	OC 1459
	
AÇIKLAMA	RENAULT 9 AMORTİSÖR ÜST BURCU
DESCRIPTION	SHOCK UPPER BUSH
ORJINAL NO	
OEM REF	

OTO CAN REF	OC 1460
	
AÇIKLAMA	DACIA LOGAN MCV II AMORTİSÖR ÜST BURCU
DESCRIPTION	SHOCK UPPER BUSH
ORJINAL NO	
OEM REF	

OTO CAN REF	OC 1461
	
AÇIKLAMA	DACIA LOGAN II MCV AMORTİSÖR ALT BURCU
DESCRIPTION	SHOCK LOWER BUSH
ORJINAL NO	
OEM REF	

OTO CAN REF	
	
AÇIKLAMA	
DESCRIPTION	
ORJINAL NO	
OEM REF	

OTO CAN REF	
	
AÇIKLAMA	
DESCRIPTION	
ORJINAL NO	
OEM REF	

OTO CAN REF	
	
AÇIKLAMA	
DESCRIPTION	
ORJINAL NO	
OEM REF	

Bu kataloktaki araç, marka, model ve OEM numaraları bilgilendirme amaçlı kullanılmıştır.

OTO CAN REF	OC108
	
AÇIKLAMA	HYUNDAI H100 STAREX KAMYONET PANANELVAN MİNİBÜS SALINCAK MİLİ
DESCRIPTION	SILT R/L
ORJINAL NO	
OEM REF	

OTO CAN REF	OC406
	
AÇIKLAMA	L300 MITSUBICHI PANELVAN MİNİBÜS SALINCAK MİLİ
DESCRIPTION	SILT R/L
ORJINAL NO	
OEM REF	

OTO CAN REF	OC116
	
AÇIKLAMA	HYUNDAI STAREX KAMYONET PANELVAN MİNİBÜS SALINCAK CİVATASI
DESCRIPTION	LOWER SILENT BOLT R/L
ORJINAL NO	
OEM REF	

OTO CAN REF	OC315
	
AÇIKLAMA	HYUNDAI PANELVAN SALINCAK CİVATASI
DESCRIPTION	LOWER SILENT BOLT R/L
ORJINAL NO	
OEM REF	

OTO CAN REF	OC215
	
AÇIKLAMA	HYUNDAI KAMYONET PANELVAN ALT SALINCAK VİRAJ ÇUBUĞU YENİ MODEL
DESCRIPTION	LOWER SILENT BLOCK NEW MODEL
ORJINAL NO	
OEM REF	

OTO CAN REF	OC216
	
AÇIKLAMA	HYUNDAI KAMYONET PANELVAN ALT SALINCAK VİRAJ ÇUBUĞU ESKİ MODEL
DESCRIPTION	LOWER SILENT BLOCK OLD MODEL
ORJINAL NO	
OEM REF	

Bu kataloktaki araç, marka, model ve OEM numaraları bilgilendirme amaçlı kullanılmıştır.

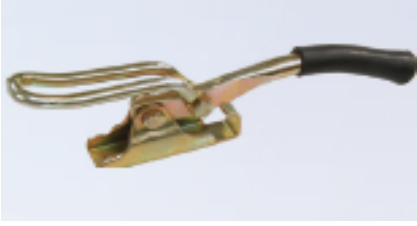
OTO CAN REF	OC217
	
AÇIKLAMA	HYUNDAI KAMYONET KASA MANDALI
DESCRIPTION	CASE CATCH
ORJINAL NO	
OEM REF	

OTO CAN REF	OC413
	
AÇIKLAMA	L300 MITSUBICHI PANELVAN MİNİBÜS VİRAJ ÇUBUĞU
DESCRIPTION	STABILIZER BAR
ORJINAL NO	
OEM REF	MR-241349

OTO CAN REF	OC1901
	
AÇIKLAMA	MITSUBICHI LANCER/EXCEL VİRAJ ÇUBUĞU
DESCRIPTION	STABILIZER BAR
ORJINAL NO	
OEM REF	MB-241974

OTO CAN REF	OC508
	
AÇIKLAMA	HYUNDAI ACCENT YENİ/ESKİ KASA VİRAJ ÇUBUĞU
DESCRIPTION	STABILIZER BAR
ORJINAL NO	
OEM REF	54825-22000

OTO CAN REF	OC1305
	
AÇIKLAMA	MAZDA 3.23 VİRAJ ÇUBUĞU
DESCRIPTION	STABILIZER ROT
ORJINAL NO	
OEM REF	

OTO CAN REF	OC1306
	
AÇIKLAMA	MAZDA B2500 VİRAJ ÇUBUĞU
DESCRIPTION	STABILIZER ROT
ORJINAL NO	
OEM REF	

Bu kataloktaki araç, marka, model ve OEM numaraları bilgilendirme amaçlı kullanılmıştır.

OTO CAN REF	OC1307
	
AÇIKLAMA	MAZDA E2200 -KIA BESTA VİRAJ ÇUBUĞU
DESCRIPTION	STABILIZER ROT
ORJINAL NO	
OEM REF	

OTO CAN REF	OC1308
	
AÇIKLAMA	MITSUBICHI L200/L300 (82-84)/PAJERO 2600(84-90) 4X4 VİRAJ ÇUBUĞU
DESCRIPTION	STABILIZER ROT
ORJINAL NO	
OEM REF	MB185477

OTO CAN REF	OC2001
	
AÇIKLAMA	HONDA CIVIC/CRX VİRAJ ÇUBUĞU 88/96
DESCRIPTION	STABILIZER ROT
ORJINAL NO	
OEM REF	

OTO CAN REF	OC2002
	
AÇIKLAMA	HONDA ACCORD VİRAJ ÇUBUĞU 90/98
DESCRIPTION	STABILIZER ROT
ORJINAL NO	
OEM REF	

OTO CAN REF	OC1109
	
AÇIKLAMA	NISSAN D21 VİRAJ ÇUBUĞU
DESCRIPTION	STABILIZER ROT
ORJINAL NO	
OEM REF	

OTO CAN REF	OC1110
	
AÇIKLAMA	NISSAN D22 VİRAJ ÇUBUĞU
DESCRIPTION	STABILIZER ROT
ORJINAL NO	
OEM REF	

Bu kataloktaki araç, marka, model ve OEM numaraları bilgilendirme amaçlı kullanılmıştır.

OTO CAN REF	OC913
	
AÇIKLAMA	ALFA ROMEO 164-FIAT KROMA VİRAJ ROTU
DESCRIPTION	STABILIZER ROT
ORJINAL NO	60570365
OEM REF	

OTO CAN REF	OC1701
	
AÇIKLAMA	SAAB 9000 VİRAJ ROTU
DESCRIPTION	STABILIZER ROT
ORJINAL NO	5454190J02
OEM REF	

OTO CAN REF	OC1201
	
AÇIKLAMA	VOLVO VİRAJ ÇUBUĞU 240/260 Ø 10 MM
DESCRIPTION	STABILIZER ROT
ORJINAL NO	1206667
OEM REF	

OTO CAN REF	OC1203
	
AÇIKLAMA	VOLVO VİRAJ ÇUBUĞU 780/940/960 Ø 12 MM
DESCRIPTION	STABILIZER ROT
ORJINAL NO	9157725
OEM REF	

OTO CAN REF	OC1204
	
AÇIKLAMA	VOLVO Z ROT 940/960/S90 1991-1998
DESCRIPTION	STABILIZER ROT
ORJINAL NO	3530304
OEM REF	

OTO CAN REF	OC716
	
AÇIKLAMA	DUCATO/CITROEN JUMPER/PEUGEOT BOXER VİRAJ ÇUBUĞU 2002-2006
DESCRIPTION	STABILIZER ROT
ORJINAL NO	1300716080
OEM REF	

Bu kataloktaki araç, marka, model ve OEM numaraları bilgilendirme amaçlı kullanılmıştır.

OTO CAN REF	OC934
	
AÇIKLAMA	DUCATO/CITROEN JUMPER/PEUGEOT BOXER VİRAJ ÇUBUĞU 2006
DESCRIPTION	STABILIZER ROT
ORJINAL NO	1357572080
OEM REF	

OTO CAN REF	OC718
	
AÇIKLAMA	CITROEN-EVASION-ULYSSE-PEUGEOT 806- EXPERT LANCIA VİRAJ ÇUBUĞU
DESCRIPTION	STABILIZER ROT
ORJINAL NO	1308664080
OEM REF	

OTO CAN REF	OC910
	
AÇIKLAMA	TEMPRA TANDIR KOLU
DESCRIPTION	STABILIZER ROT
ORJINAL NO	60570627
OEM REF	

OTO CAN REF	OC944
	
AÇIKLAMA	DOBLO ARKA BAĞLANTI ÇUBUĞU 2009/...
DESCRIPTION	STABILIZER ROT
ORJINAL NO	50468091
OEM REF	

OTO CAN REF	OC914
	
AÇIKLAMA	DKŞ 131 VİRAJ KELEÇESİ TAKIMI
DESCRIPTION	
ORJINAL NO	
OEM REF	

OTO CAN REF	OC915
	
AÇIKLAMA	FIAT PALIO SALINCAK KELEÇESİ
DESCRIPTION	
ORJINAL NO	
OEM REF	

Bu kataloktaki araç, marka, model ve OEM numaraları bilgilendirme amaçlı kullanılmıştır.

OTO CAN REF	OC931
	
AÇIKLAMA	FIAT DOBLO VİRAJ UÇ TAŞIYICI YENİ MODEL
DESCRIPTION	STABILIZER CENTER CARRIER
ORJINAL NO	46790552
OEM REF	

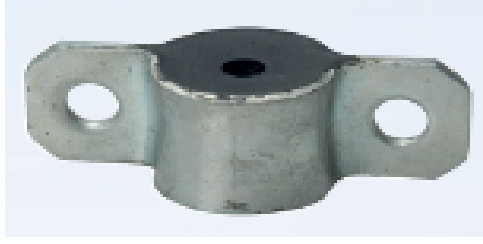
OTO CAN REF	OC932
	
AÇIKLAMA	FIAT DOBLO VİRAJ UÇ TAŞIYICI ESKİ MODEL
DESCRIPTION	STABILIZER CENTER CARRIER
ORJINAL NO	7750990
OEM REF	

OTO CAN REF	OC933
	
AÇIKLAMA	FIAT UNO VİRAJ UÇ TAŞIYICI
DESCRIPTION	STABILIZER CENTER CARRIER
ORJINAL NO	7603476
OEM REF	

OTO CAN REF	OC1401
	
AÇIKLAMA	R12 ANTİPENTEN KOLU
DESCRIPTION	REAR STABILIZER
ORJINAL NO	7700543148
OEM REF	

OTO CAN REF	OC1402
	
AÇIKLAMA	R12 VİTES LEVYE KOLU
DESCRIPTION	TANSMISSION GEARSHIFT LEVER
ORJINAL NO	7702188453
OEM REF	

OTO CAN REF	OC1403
	
AÇIKLAMA	TOROS VİTES LEVYE KOLU
DESCRIPTION	TANSMISSION GEARSHIFT LEVER
ORJINAL NO	7700507710
OEM REF	

Bu kataloktaki araç, marka, model ve OEM numaraları bilgilendirme amaçlı kullanılmıştır.

OTO CAN REF	OC1404
	
AÇIKLAMA	R12 VİRAJ TANDIR KOLU
DESCRIPTION	STABILIZER ROT
ORJINAL NO	7701453465
OEM REF	

OTO CAN REF	OC1415
	
AÇIKLAMA	RENAULT CLIO-KANGO-MEGANE I VİRAJ ÇUBUĞU
DESCRIPTION	STABILIZER ROT
ORJINAL NO	7700799404
OEM REF	

OTO CAN REF	OC1416
	
AÇIKLAMA	DACIA LOGAN-SANDERO VİRAJ ÇUBUĞU
DESCRIPTION	STABILIZER ROT
ORJINAL NO	7700799404
OEM REF	

OTO CAN REF	OC1440
	
AÇIKLAMA	DACIA DUSTER ARKA DENGE KOLU R
DESCRIPTION	REAR STABILIZER
ORJINAL NO	8200841004
OEM REF	

OTO CAN REF	OC1441
	
AÇIKLAMA	DACIA DUSTER ARKA DENGE KOLU R
DESCRIPTION	REAR STABILIZER
ORJINAL NO	8200839107
OEM REF	

OTO CAN REF	OC1442
	
AÇIKLAMA	DACIA DUSTER ARKA DENGE KOLU UZUN
DESCRIPTION	REAR STABILIZER
ORJINAL NO	8200839119
OEM REF	

Bu kataloktaki araç, marka, model ve OEM numaraları bilgilendirme amaçlı kullanılmıştır.

OTO CAN REF	OC1443
	
AÇIKLAMA	DACIA DUSTER ARKA DENGE KOLU KISA
DESCRIPTION	REAR STABILIZER
ORJINAL NO	8200839124
OEM REF	

OTO CAN REF	OC1302
	
AÇIKLAMA	KIA BESTA EGZOS BOĞAZ CONTASI BÜYÜK
DESCRIPTION	EXHAUST NECK GASKET BIG
ORJINAL NO	
OEM REF	

OTO CAN REF	OC1303
	
AÇIKLAMA	KIA BESTA EGZOS BOĞAZ CONTASI KÜÇÜK
DESCRIPTION	EXHAUST NECK GASKET SMALL
ORJINAL NO	
OEM REF	

OTO CAN REF	OC1116
	
AÇIKLAMA	NISSAN D22 SALINCAK CİVATASI
DESCRIPTION	LOWER SILENT BOLT R/L
ORJINAL NO	
OEM REF	

OTO CAN REF	OC1309
	
AÇIKLAMA	MITSUBICHI L200 SALINCAK CİVATASI
DESCRIPTION	LOWER SILENT BOLT R/L
ORJINAL NO	
OEM REF	

OTO CAN REF	OC1310
	
AÇIKLAMA	MITSUBICHI CARISMA SALINCAK CİVATASI
DESCRIPTION	LOWER SILENT BOLT R/L
ORJINAL NO	
OEM REF	

Bu kataloktaki araç, marka, model ve OEM numaraları bilgilendirme amaçlı kullanılmıştır.

OTO CAN REF	OC3002
	
AÇIKLAMA	TOYOTA HILUX SALINCAK CİVATASI 2007/....
DESCRIPTION	LOWER SILENT BOLT R/L
ORJINAL NO	
OEM REF	

OTO CAN REF	OC218
	
AÇIKLAMA	H100 MAKAS KÜPESİ
DESCRIPTION	
ORJINAL NO	
OEM REF	

OTO CAN REF	OC219
	
AÇIKLAMA	KAMYONET MAKAS KÜPESİ
DESCRIPTION	
ORJINAL NO	
OEM REF	

OTO CAN REF	OC220
	
AÇIKLAMA	H100/L300 KARTER TAPASI
DESCRIPTION	
ORJINAL NO	
OEM REF	

OTO CAN REF	
	
AÇIKLAMA	
DESCRIPTION	
ORJINAL NO	
OEM REF	

OTO CAN REF	
	
AÇIKLAMA	
DESCRIPTION	
ORJINAL NO	
OEM REF	

Bu kataloktaki araç, marka, model ve OEM numaraları bilgilendirme amaçlı kullanılmıştır.

OTO CAN REF	OC109
	
AÇIKLAMA	HYUNDAI STAREX DEBRİYAJ ÇATALI
DESCRIPTION	CLUTCH FORK
ORJINAL NO	
OEM REF	

OTO CAN REF	OC516
	
AÇIKLAMA	HYUNDAI ACCENT YENİ KASA DEBRİYAJ ÇATALI
DESCRIPTION	CLUTCH FORK
ORJINAL NO	
OEM REF	

OTO CAN REF	OC1806
	
AÇIKLAMA	HYUNDAI ERA DEBRİYAJ ÇATALI
DESCRIPTION	CLUTCH FORK
ORJINAL NO	
OEM REF	

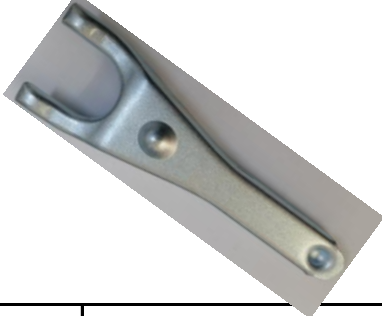
OTO CAN REF	OC3001
	
AÇIKLAMA	TOYOTA HILUX/HIACE DEBRİYAJ ÇATALI
DESCRIPTION	CLUTCH FORK
ORJINAL NO	31204-35050
OEM REF	

OTO CAN REF	OC1304
	
AÇIKLAMA	MAZDA E2200 DEBRİYAJ ÇATALI
DESCRIPTION	CLUTCH FORK
ORJINAL NO	
OEM REF	

OTO CAN REF	OC1301
	
AÇIKLAMA	KIA BESTA DEBRİYAJ ÇATALI
DESCRIPTION	CLUTCH FORK
ORJINAL NO	
OEM REF	

Bu kataloktaki araç, marka, model ve OEM numaraları bilgilendirme amaçlı kullanılmıştır.

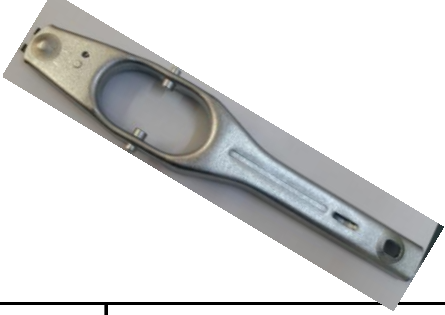
OTO CAN REF	OC945
	
AÇIKLAMA	FIAT DKŞ/1600 DEBRİYAJ ÇATALI
DESCRIPTION	CLUTCH FORK
ORJINAL NO	
OEM REF	

OTO CAN REF	OC1449
	
AÇIKLAMA	BOXER-JUMPER 2.2 HDI/206/C3/X SARA DEBRİYAJ ÇATALI
DESCRIPTION	CLUTCH FORK
ORJINAL NO	
OEM REF	2117.65

OTO CAN REF	OC
	
AÇIKLAMA	
DESCRIPTION	
ORJINAL NO	
OEM REF	

OTO CAN REF	OC
	
AÇIKLAMA	
DESCRIPTION	
ORJINAL NO	
OEM REF	

OTO CAN REF	OC
	
AÇIKLAMA	
DESCRIPTION	
ORJINAL NO	
OEM REF	

OTO CAN REF	OC
	
AÇIKLAMA	
DESCRIPTION	
ORJINAL NO	
OEM REF	

Bu kataloktaki araç, marka, model ve OEM numaraları bilgilendirme amaçlı kullanılmıştır.

OTO CAN REF	OC1601
	
AÇIKLAMA	MITSUBICHI CANTER AKS YAĞ KAPAĞI TEK TEKER
DESCRIPTION	
ORJINAL NO	
OEM REF	

OTO CAN REF	OC1602
	
AÇIKLAMA	MITSUBICHI CANTER AKS YAĞ KAPAĞI ÇİFT TEKER
DESCRIPTION	
ORJINAL NO	
OEM REF	

OTO CAN REF	OC1603
	
AÇIKLAMA	MAZDA E2200/KIA BESTA AKS KAPAĞI
DESCRIPTION	
ORJINAL NO	
OEM REF	S0833071

OTO CAN REF	OC1604
	
AÇIKLAMA	H100/L300 AKS KAPAĞI
DESCRIPTION	
ORJINAL NO	
OEM REF	

OTO CAN REF	OC1605
	
AÇIKLAMA	R12 AKS KAPAĞI
DESCRIPTION	
ORJINAL NO	
OEM REF	7703075084

OTO CAN REF	OC1606
	
AÇIKLAMA	R9/LAGUNA III/KANGOO III AKS KAPAĞI
DESCRIPTION	
ORJINAL NO	
OEM REF	7700754393

Bu kataloktaki araç, marka, model ve OEM numaraları bilgilendirme amaçlı kullanılmıştır.

OTO CAN REF	OC1607
	
AÇIKLAMA	FIAT DOBLO AKS KAPAĞI
DESCRIPTION	
ORJINAL NO	
OEM REF	

OTO CAN REF	OC1608
	
AÇIKLAMA	FIAT TIPO/TEMPRA AKS KAPAĞI
DESCRIPTION	
ORJINAL NO	
OEM REF	

OTO CAN REF	OC1609
	
AÇIKLAMA	FIAT 131-DKŞ AKS YAĞ KAPAĞI
DESCRIPTION	
ORJINAL NO	
OEM REF	4410279

OTO CAN REF	OC
	
AÇIKLAMA	
DESCRIPTION	
ORJINAL NO	
OEM REF	

OTO CAN REF	OC
	
AÇIKLAMA	
DESCRIPTION	
ORJINAL NO	
OEM REF	

OTO CAN REF	OC
	
AÇIKLAMA	
DESCRIPTION	
ORJINAL NO	
OEM REF	

Bu kataloktaki araç, marka, model ve OEM numaraları bilgilendirme amaçlı kullanılmıştır.

OTO CAN REF	OC1501
	
AÇIKLAMA	Ø 50 MM BLOK SU TAPASI
DESCRIPTION	
ORJINAL NO	
OEM REF	

OTO CAN REF	OC1502
	
AÇIKLAMA	Ø 45 MM BLOK SU TAPASI
DESCRIPTION	
ORJINAL NO	
OEM REF	

OTO CAN REF	OC1503
	
AÇIKLAMA	Ø 40 MM BLOK SU TAPASI
DESCRIPTION	
ORJINAL NO	
OEM REF	

OTO CAN REF	OC1504
	
AÇIKLAMA	Ø 38 MM BLOK SU TAPASI
DESCRIPTION	
ORJINAL NO	
OEM REF	

OTO CAN REF	OC1505
	
AÇIKLAMA	Ø 36 MM BLOK SU TAPASI
DESCRIPTION	
ORJINAL NO	
OEM REF	

OTO CAN REF	OC1506
	
AÇIKLAMA	Ø 35 MM BLOK SU TAPASI
DESCRIPTION	
ORJINAL NO	
OEM REF	

Bu kataloktaki araç, marka, model ve OEM numaraları bilgilendirme amaçlı kullanılmıştır.

OTO CAN REF	OC1507
	
AÇIKLAMA	Ø 32 MM BLOK SU TAPASI
DESCRIPTION	
ORJINAL NO	
OEM REF	

OTO CAN REF	OC1508
	
AÇIKLAMA	Ø 30 MM BLOK SU TAPASI
DESCRIPTION	
ORJINAL NO	
OEM REF	

OTO CAN REF	OC1509
	
AÇIKLAMA	Ø 28 MM BLOK SU TAPASI
DESCRIPTION	
ORJINAL NO	
OEM REF	

OTO CAN REF	OC1510
	
AÇIKLAMA	Ø 25 MM BLOK SU TAPASI
DESCRIPTION	
ORJINAL NO	
OEM REF	

OTO CAN REF	OC1511
	
AÇIKLAMA	Ø 22 MM BLOK SU TAPASI
DESCRIPTION	
ORJINAL NO	
OEM REF	

OTO CAN REF	OC1512
	
AÇIKLAMA	Ø 21 MM BLOK SU TAPASI
DESCRIPTION	
ORJINAL NO	
OEM REF	

Bu kataloktaki araç, marka, model ve OEM numaraları bilgilendirme amaçlı kullanılmıştır.

OTO CAN REF	OC1513
	
AÇIKLAMA	Ø 20 MM BLOK SU TAPASI
DESCRIPTION	
ORJINAL NO	
OEM REF	

OTO CAN REF	OC1514
	
AÇIKLAMA	Ø 18 MM BLOK SU TAPASI
DESCRIPTION	
ORJINAL NO	
OEM REF	

OTO CAN REF	OC1515
	
AÇIKLAMA	Ø 16 MM BLOK SU TAPASI
DESCRIPTION	
ORJINAL NO	
OEM REF	

OTO CAN REF	OC1516
	
AÇIKLAMA	Ø 14 MM BLOK SU TAPASI
DESCRIPTION	
ORJINAL NO	
OEM REF	

OTO CAN REF	OC1517
	
AÇIKLAMA	Ø 12 MM BLOK SU TAPASI
DESCRIPTION	
ORJINAL NO	
OEM REF	

OTO CAN REF	OC1518
	
AÇIKLAMA	Ø 10 MM BLOK SU TAPASI
DESCRIPTION	
ORJINAL NO	
OEM REF	

Bu kataloktaki araç, marka, model ve OEM numaraları bilgilendirme amaçlı kullanılmıştır.

OTO CAN REF	OC1525
	
AÇIKLAMA	Ø 34 MM BLOK SU TAPASI
DESCRIPTION	
ORJINAL NO	
OEM REF	

OTO CAN REF	OC1526
	
AÇIKLAMA	Ø 24 MM BLOK SU TAPASI
DESCRIPTION	
ORJINAL NO	
OEM REF	

OTO CAN REF	OC1527
	
AÇIKLAMA	Ø 27 MM BLOK SU TAPASI
DESCRIPTION	
ORJINAL NO	
OEM REF	

OTO CAN REF	OC1528
	
AÇIKLAMA	Ø 26 MM BLOK SU TAPASI
DESCRIPTION	
ORJINAL NO	
OEM REF	

OTO CAN REF	OC1529
	
AÇIKLAMA	Ø 31 MM BLOK SU TAPASI
DESCRIPTION	
ORJINAL NO	
OEM REF	

OTO CAN REF	OC1530
	
AÇIKLAMA	Ø 33 MM BLOK SU TAPASI
DESCRIPTION	
ORJINAL NO	
OEM REF	

Bu kataloktaki araç, marka, model ve OEM numaraları bilgilendirme amaçlı kullanılmıştır.

OTO CAN REF	OC1531
	
AÇIKLAMA	Ø 37 MM BLOK SU TAPASI
DESCRIPTION	
ORJINAL NO	
OEM REF	

OTO CAN REF	OC1532
	
AÇIKLAMA	Ø 29 MM BLOK SU TAPASI
DESCRIPTION	
ORJINAL NO	
OEM REF	

OTO CAN REF	
	
AÇIKLAMA	
DESCRIPTION	
ORJINAL NO	
OEM REF	

OTO CAN REF	
	
AÇIKLAMA	
DESCRIPTION	
ORJINAL NO	
OEM REF	

OTO CAN REF	
	
AÇIKLAMA	
DESCRIPTION	
ORJINAL NO	
OEM REF	

OTO CAN REF	
	
AÇIKLAMA	
DESCRIPTION	
ORJINAL NO	
OEM REF	

Bu kataloktaki araç, marka, model ve OEM numaraları bilgilendirme amaçlı kullanılmıştır.

OTO CAN REF	OC1519
	
AÇIKLAMA	H100/L300 BLOK SU TAPA TAKIMI
DESCRIPTION	
ORJINAL NO	
OEM REF	

OTO CAN REF	OC1520
	
AÇIKLAMA	KIA CERES BLOK SU TAPA TAKIMI
DESCRIPTION	
ORJINAL NO	
OEM REF	

OTO CAN REF	OC1521
	
AÇIKLAMA	KIA BESTA BLOK SU TAPA TAKIMI
DESCRIPTION	
ORJINAL NO	
OEM REF	

OTO CAN REF	OC1522
	
AÇIKLAMA	KIA BONGO-PREJO 2700 KAPAK SU TAPA TAKIMI
DESCRIPTION	
ORJINAL NO	
OEM REF	

OTO CAN REF	OC1523
	
AÇIKLAMA	KIA BONGO-PREJO 2700 BLOK SU TAPA TAKIMI
DESCRIPTION	
ORJINAL NO	
OEM REF	

OTO CAN REF	OC1524
	
AÇIKLAMA	KIA CERES KAPAK SU TAPA TAKIMI
DESCRIPTION	
ORJINAL NO	
OEM REF	

Bu kataloktaki araç, marka, model ve OEM numaraları bilgilendirme amaçlı kullanılmıştır.

